

ADRCV2460

60W 24V DC Constant Voltage
LED Driver

Drive24



PRODUCT FEATURES

- 24V DC Constant Voltage LED Power Supply
- Over Temperature Protection
- Overload Protection
- No Load Protection
- Regulated Output
- SELV Rated

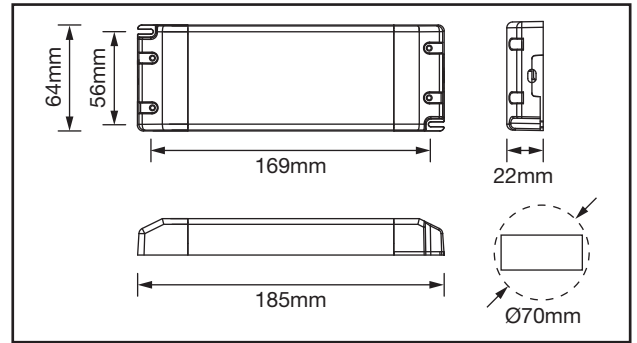

TECHNICAL SPECIFICATIONS

Product Code	ADRCV2460
Operating Voltage	220-240V AC
Operating Current (A Max)	0.4A
Max Output Power	0 - 60W
Output Current (Max)	2.5A
Output Voltage	24V DC
Power Factor	>0.9
Efficiency %	89%
No Load Power (W)	<0.5W
Dimmable	No
Class	II
Body Material	Polymer
Frame Colour	White (Blue Caps)
Switching Cycles	>100,000
Ingress Protection	IP20
Ambient Operating Temperature (°C)	-20°C ~ +50°C
Input Frequency (Hz)	50/60Hz
Guarantee	5 Years
Lifetime	30,000 Hrs
Displacement Factor	>0.9
Inrush Current	39.8A, 0.84µs
Over Temperature Protection	Yes
Overload Protection	Yes
No Load Protection	Yes